

Data Sheet



Article number: 12522800250100

Description: KLEE-coil 522 800 250.100
M5 Hardened, zinc-pl. & chr. yellow

Measures

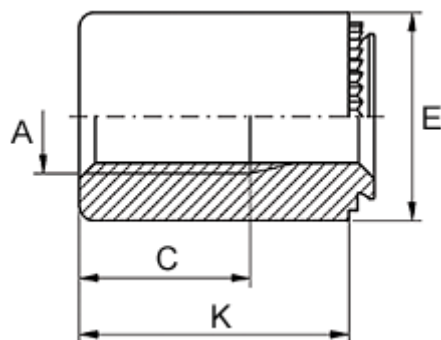

Female thread A	= M5
Height K	= 22
Min distance to edge	= 4.0
Outer diameter E	= 9
Plate thickness	= 1.5 to 2.3
Recommended bore diameter +0.05	= 6.00
Thread length	= 8.0